



# Minelab 'GP 3000'

## AN IMPORTANT MESSAGE FROM MINELAB

We ask YOU, as a responsible detector operator, to take all due care regarding the environment.

Minelab cannot stress enough the importance of being responsible when recovering targets.

### BACKFILL EVERY HOLE YOU DIG.

If care and consideration is taken, during and after the removal of targets, especially with respect to the back filling of holes, this should ensure the continued access to areas for prospecting and treasure hunting. This will also ensure that the pristine condition of our beautiful bushland, forests and dry land areas is maintained with a minimum of damage.

Minelab is working with you towards preserving our natural environment so that the benefits of gold prospecting and treasure hunting can continue to be enjoyed in the years to come.

Every prospector and treasure hunter around the world and the staff of Minelab thank you for your continued efforts towards protecting the environment.

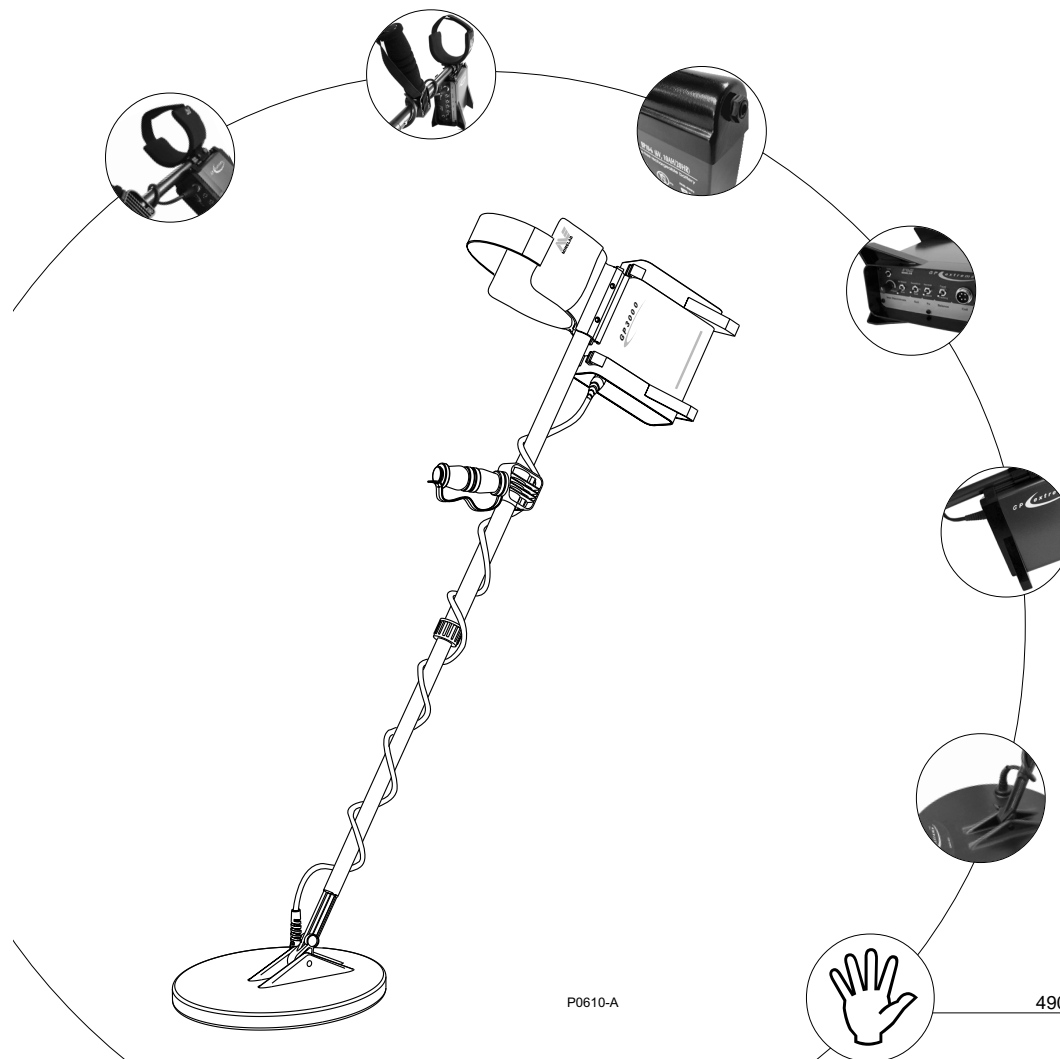

P0610-A

4901-0036 Version 1.2



© Minelab Electronics Pty Ltd

This document contains proprietary information which is protected by copyright. Apart from any use as permitted under the Copyright Act 1968, no part may be reproduced by any process without written permission from Minelab Electronics Pty Ltd, 118 Hayward Avenue, Torrensville, SA 5031, Australia.

**WARNING.** This document contains Minelab Electronics Pty Ltd rights, technical data or restricted rights data, or both. Patents and trademarks apply.

Since there may be a range of options available in this detector type, equipment may vary according to the model or items ordered with your detector. Certain descriptions and illustrations may differ (in this manual) from the exact model that you purchased. In addition, Minelab reserve the right to respond to ongoing technical progress by introducing changes in design, equipment and technical features at any time.

## DETECTOR CARE AND SAFETY

# take care

*The 'GP 3000' is a high quality electronic instrument. It has been designed for professional gold prospecting use and the electronics circuitry is encased in a rugged housing. Take care of your detector in the following way:*

**Keep the detector clean and dry.** It is *very important* to keep all electrical connectors clean and dry.

**The control box is not waterproof**, even though it has been designed to be water-resistant. Take care to avoid it becoming wet.

The coil is water resistant and may be used in rain or wet conditions. The coil is not waterproof. **Do not immerse the coil in water.**

Regularly replace such items as teardrop washers and skidplates to give long life to your detector.

**Do not expose the detector to high temperatures** or leave it in the sun for longer than is necessary. Shading will help protect it. Do not leave the detector in a closed vehicle, especially in the sun.

The coil housing will eventually wear through if you scrub the ground with it while searching. Use of a replaceable skid plate will help to protect your coils.

To prevent dirt entering between the coil and the skidplate, silk tape, e.g. Leukosilk®, which is available from chemists, may be used. The use of some other tapes, e.g. insulation tape, may result in some loss of sensitivity.

The control box and coil should not come into contact with petrol or other oil-based liquids. If any part of the detector comes into contact with corrosive substances, including salt or salt water, it should be washed with fresh water.

Clean the detector with a damp cloth using a mild soap detergent. Do not use solvents.

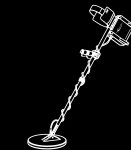

# contents

- 1 INTRODUCTION ..... 1**
  - About this manual ..... 2
  - Introducing the Minelab 'GP 3000' ..... 3
  
- 2 ASSEMBLY ..... 5**
  - Unpacking your 'GP 3000' [easy reference] ..... 6
  - List of pre-assembled sections and parts ..... 7
  - Complete assembly instructions ..... 8
  
- 3 BATTERY ..... 13**
  - Battery and charging ..... 14
  
- 4 CONTROLS ..... 17**
  - Detector sounds [easy reference] ..... 18
  - Control functions: rear panel ..... 19
  - Control functions: front panel ..... 23
  
- 5 OPERATION ..... 27**
  - Quick start instructions [easy reference] ..... 28
  - Detailed operating instructions ..... 29
  - Ground balancing ..... 33
  - Iron discrimination ..... 35
  - Level Adjust Control ..... 37



TABLE OF CONTENTS

# contents

<b>6</b>	<b>DETECTING TECHNIQUES</b> .....	<b>39</b>
	Detecting techniques .....	40
	Prospecting techniques .....	42
	Identifying target signals .....	43
	Recovering the target .....	45
<b>7</b>	<b>USER INFORMATION</b> .....	<b>49</b>
	Technical specifications for the Minelab 'GP 3000' .....	50
	Troubleshooting .....	51
	Service repair form .....	52
	Warranty .....	53
	Accessories .....	54
	Glossary of common terms .....	55
	Detector care and safety .....	59
	An important message from Minelab .....	60

- Salt** The presence of high salt content in the ground being searched will have a similar but different effect on the metal detector ground balance as does mineralisation.  
  
Salt content causes a negative (-) response rather than the positive (+) response of laterite soils. The detector needs to therefore use different filtering techniques to overcome this effect.
- Search Coil** The search coil is the circular plate which is swept across the ground surface during detecting. It transmits electromagnetic signals into the ground and receives the response.
- Search Pattern** The search pattern is the area of ground underneath the coil which is being scanned. Depending on the style of coil (Double D or Monoloop) and the **Coil** mode being operated in (**Double D/M/Cancel**) different coils will have a different shaped area being covered by each sweep.
- Threshold** The continuous audible level of sound emitted by the detector is referred to as the **Threshold**. This threshold hum is the background sound made as the detector operates. **Threshold** can be set anywhere between silent and loud, but a soft, audible level is normally suggested.
- Target Response** The electro-magnetic effect generated by the metal target under the influence of the TX field.
- Target Signal** The audio signal (or change in threshold) caused by the presence of a metal target as the coil passes across it.
- Tracking** The function of Automatic Ground Balance where the 'GP 3000' makes continuous adjustments to the ground balance to compensate for changes in the mineralisation of the ground.
- TX** TX refers to the transmit signals or electromagnetic pulses, sent into the ground by the coil.



## 1

# Introduction

The 'GP 3000' incorporates new technological advances and control functions which have resulted in a detector that combines stable and effective ground balancing with depth and sensitivity.



**Halo Effect** After a metal object has remained undisturbed in the soil for a considerable amount of time, a diffusion occurs around the object. This has the effect of the object appearing to the detector to be a larger size.

**Hot Rocks** A hot rock is an individual rock which has a particularly high degree of mineralisation as compared to the average ground around it. Due to this high difference, the detector does not have the opportunity to ground balance on the individual rock so therefore gives a false signal.

**Interference** Electricity or radio waves in the area being detected can cause instability or chattering of the detectors threshold.

The types of interference commonly occur due to power lines, underground cables, radar, other detectors or climatic conditions like thunderstorms.

**Mineralised Ground** Most ground contains certain minerals which can cause false signals to be given by a detector. Heavily mineralised ground requires different ground processing than does neutral or lightly mineralised ground (see Ground Balance).

Ground containing heavy salt concentrations require entirely different processing again (see salt).

**Monoloop Coils** Monoloop coils are the style of coil where the multiple strands of wire are wound in a single loop around the circumference of the coil. The field of search of Monoloop coils tend to be cone shaped.

**Non - Ferrous Metals** Metals not containing significant levels of iron. Non-ferrous metals are non-magnetic such as Gold, Silver, Copper, Brass, Lead or Aluminium.

**Pinpoint** The method of locating the precise location of a target prior to digging. Pinpointing uses the design of the search coil windings to determine the exact position of the detected target.

**RX** RX refers to the response or electromagnetic field which is received back by the coil and is used by the control box circuitry to detect a metal item in the ground.



## ABOUT THIS MANUAL

*This manual is designed to introduce the detector's features. It gives you step-by-step directions for everything from assembling and adjusting your detector, to basic and advanced detector use.*



### 1. INTRODUCTION

Basic overview of the 'GP 3000' and this User's Manual.



### 2. ASSEMBLY

This chapter provides details and instructions on assembling and adjusting the 'GP 3000'.



### 3. BATTERY

The 'GP 3000' is powered by a rechargeable battery pack. This chapter provides details on battery installation, use and performance.



### 4. CONTROLS

This chapter is designed to familiarize you with the various features of the 'GP3000' control panel. A few minutes spent reading this chapter will be a worthwhile preliminary to basic or advanced detecting.



### 5. DETECTOR OPERATION

However experienced you are at using a metal detector, it is important that you read this.



### 6. DETECTOR TECHNIQUES

Once you are comfortable with the basic detector use, there are a few techniques you should be aware of.



### 7. USER INFORMATION

This chapter provides a glossary of terminology, user guides, technical specifications, warranty and repair details and troubleshooting tips.

## GLOSSARY OF COMMON TERMS

**Control Box** The control box encloses the electronic circuitry of the detector. The control box originates the TX (transmit) signals sent by the coil and interprets the RX (receive) signals detected by the coil. All user selectable functions (knobs & switches) are located on the front and rear panels of the control box.

**Discrimination** The ability of a metal detector to estimate if a located target is made from ferrous metal (iron or steel) or non-ferrous metal (non-magnetic).

**Double D Coils** Double D coils are coils that have two windings of wire that overlap in the shape of two D's (one reversed). The characteristics of a Double D coil are stability, especially in heavily mineralised ground, good depth and sensitivity and a very thorough search pattern.

**Electromagnetic Field** Commonly called the 'signal from the coil'. An electromagnetic field is generated within the wire windings of the search coil and this field is pulsed or sent into the ground. The presence of a metal target in the ground will disturb the pattern of this field and this disturbance is registered by the receive system of the detector and indicated to the operator by an audible target signal "beep".

**False Signal** False signals are signals, which sound similar to target signals but are caused by other factors. Common causes for false signals are incorrect ground balance, hot rocks, signals caused by knocking the coil on obstacles, etc. With experience, the operator will learn methods to minimise false signals and to hear subtle differences between target signals and false signals.

**Ferrous Metals** Metals composed of or containing iron. A ferrous item is one which is attracted to a magnet and is predominantly or completely made of iron or steel.

**Ground Balance** The ability of the metal detector to compensate for the effects of ground mineralisation. The 'GP 3000' has "automatic ground balance". When it is used in **Tracking** mode it continually compensates for changes in the ground mineralisation.



## ACCESSORIES

### Search coils

The 'GP 3000' is supplied with the 'GP 3000' 1100 and 'GP 3000' 1800 coils. These coils have been specially designed to take advantage of the new technology and features of this detector. In addition to this there are also a number of other size coils will become available in the near future.

These range from smaller coils which give greater sensitivity to small targets and are lighter and manouverable in heavy vegetation, up to larger coils which give greater depth. See your Minelab retailer for the full range.

In some circumstances, other Double D and Monoloop coils will work on the 'GP 3000', however there are limitations which will mean that a number of the new benefits of the DVT will not work properly. In some cases the use of coils not designed for the 'GP 3000' will cause the detector to be unstable and noisy.

### Batteries

Spare 12A/hr batteries can be an advantage, especially if travelling into the outback.

A smaller light-weight battery is also available from Minelab. This is rated at 4.5A/hr and gives approx. 3 - 4 hours running time per charge. The weight of this battery is 968g.

### Corporate clothing

Minelab also has a range of good quality clothing, e.g. caps, shirts and jackets available. Ask your local dealer for details.

## INTRODUCING THE MINELAB 'GP 3000'

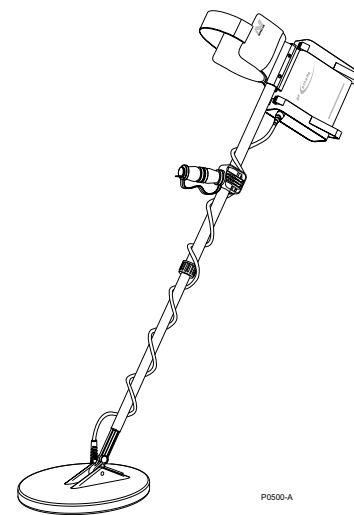

The Minelab 'GP 3000' utilises "Dual Voltage Technology" (DVT), which is based upon the Bi-polar technology used in our military range.

Here are some features of the 'GP 3000':

- NEW Low-Noise circuitry
- NEW battery harness
- NEW "Smart Point" diagnostic port
- DVT technology for optimum depth and sensitivity in all soil types
- Long-life 12A/hr Gel Cell battery
- Selectable Tx (transmit) modes (Soil Switch) for optimum performance in different soil conditions
- Selectable Rx (receive) modes (Coil Switch) for greater sensitivity and less susceptibility to interference
- Heavy Duty Bungy Strap

Like its predecessor, the 'GP extreme', the 'GP 3000' can handle heavily mineralised and salty ground conditions with greater ease than previous detectors, which effectively opens up NEW detecting areas. The new Low-Noise circuitry found in the 'GP 3000' results in a smoother threshold, enhancing your ability to hear faint signals caused by small and deep targets. This allows you to revisit old "worked-out" areas, and find the gold others have missed.

Minelab wished to thank you for purchasing our most advanced gold detector ever, and are confident the 'GP 3000' will lead you to success in your quest for gold and treasure.



## Contact Minelab

Minelab is always interested in your opinions so if you have any questions or comments regarding the 'GP 3000' or any other Minelab product, please feel free to contact us via your local Authorized Minelab dealer, or write to us:

Minelab Electronics Pty Ltd PO Box 537 Torrensville Plaza South Australia 5031 AUSTRALIA email: ho@minelab.com.au tel: + 61 (8) 8238 0888	Minelab USA 2700 E Patrick Lane, Suite 11 Las Vegas, Nevada 89120 UNITED STATES OF AMERICA email: minelab@minelabusa.com tel: + 1 (702) 891 8809	Minelab International Limited Laragh, Bandon Co. Cork IRELAND email: minelab@minelab.ie tel: + 353 (23) 52101
--	---	--



Visit our site on the World Wide Web: <http://www.minelab.com> for the latest information on Minelab products and services.

## WARRANTY

### Repairs

In the unfortunate circumstance that the detector needs to be returned to Minelab for service, please fill out the Minelab Service Repair Form (or a photocopy of the same) and enclose it with the detector.

Please supply as much detail about the fault as possible. This will assist our service engineers to rectify the problem quickly and efficiently.

The 'GP 3000' control box has a 2 year warranty covering parts and labour. Refer to your warranty card for details.

The 'GP 3000' 1100 and 1800 coils have a warranty for one year against malfunction. Refer to either your supplier or Minelab directly for service.

The commencement of the warranty is the date of purchase.

The Minelab warranty does not cover damage caused by accident, misuse, neglect, alteration, modifications or unauthorised service.

For specific details of the Minelab warranty please refer to the Product Warranty card.

It is the responsibility of the owner to pay all transport costs for the detector to Minelab.

The repaired detector will be returned to the owner freight free.

**NOTE** This warranty is not transferable or valid unless the enclosed warranty registration card is returned to Minelab Electronics Pty. Ltd. or an authorised Minelab Electronics Pty. Ltd. regional distributor within 14 days of the original purchase.





### SERVICE REPAIR FORM

Today's Date \_\_\_\_\_

Detector Model \_\_\_\_\_ Serial No. \_\_\_\_\_

Purchased From \_\_\_\_\_

Purchase Date \_\_\_\_\_

Faulty Part(s): \_\_\_\_\_

Description of Fault: \_\_\_\_\_

\_\_\_\_\_  
\_\_\_\_\_  
\_\_\_\_\_

*If necessary, use the space provided overleaf to continue your description of the fault.*

Owner's Name \_\_\_\_\_

Address \_\_\_\_\_

\_\_\_\_\_

Phone Day ( ) \_\_\_\_\_ Home ( ) \_\_\_\_\_

Fax ( ) \_\_\_\_\_ Email \_\_\_\_\_

# 2

# Assembly

This chapter provides details and instructions on assembling and adjusting the 'GP 3000'.





UNPACKING YOUR 'GP 3000'

# easy reference

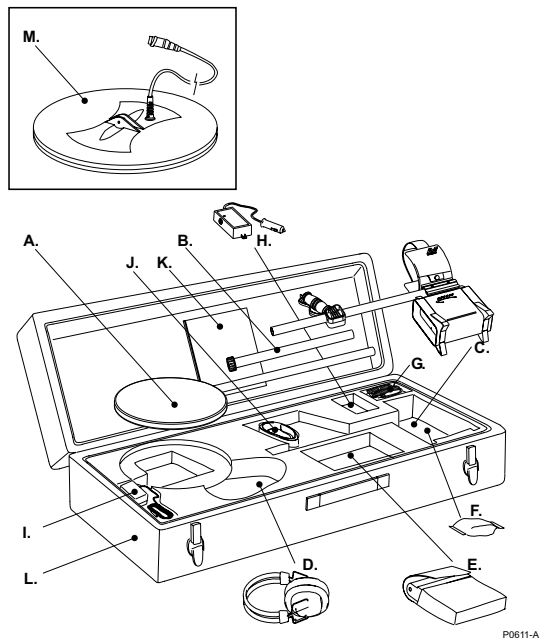

Figure 2.1 Contents of the 'GP 3000' pack.

The 'GP 3000' as shipped

A. 11" Double D Coil with Skid Plate and Fibreglass Lower Shaft

TROUBLESHOOTING

Use the following table to check for suggested solutions to problems.

Table 7.2 Troubleshooting

FAULT	SUGGESTION
No sound	Turn <b>Threshold</b> control fully clockwise. Turn <b>Volume</b> control clockwise. Check power cable and connections. Check headphones. Check battery.
Threshold but no target signal.	Check coil is connected. Try testing different coils.
Random noises.	Check for other detectors interfering. Retune using <b>Tuning</b> button. Charge the battery. Set <b>Coil</b> to <b>Cancel</b> . Re-ground balance. Check for thunderstorm build-up.
Battery will not charge using vehicle charger.	Check for power to cigarette lighter socket in vehicle. Check 10 amp fuse in charger plug.
Battery not holding charge.	Try alternative charger. Check power cable.
Very noisy threshold.	Check for interference and re-tune. Try detecting in a different location. Set <b>Coil</b> to <b>Cancel</b> .

If you need to return your detector to Minelab for service, please supply as many details as possible about the fault. This will enable our service engineers to rectify the fault quickly and efficiently.

Return the detector in a cardboard box for protection along with the **Service Repair Form** supplied in this manual.

Please supply your name, address and phone number along with purchase date and serial number when sending detector parts for repair.



## TECHNICAL SPECIFICATIONS

### The 'GP extreme'

Table 7.1 Technical specifications

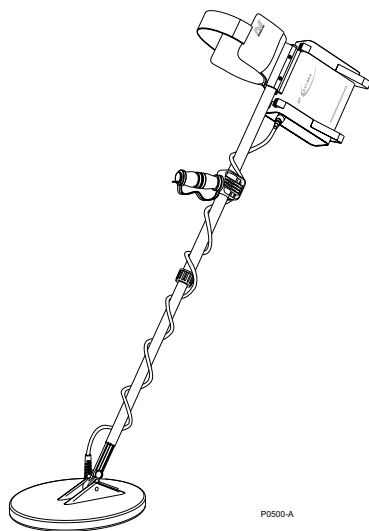

Length	Maximum	1300mm
	Minimum	1100mm
Weight	Complete with 11" coil (excluding battery)	2400g
Configuration	Shaftmount	
Transmit Freq.	Bi-level Pulse Induction	
Technology	Dual Voltage Technology (DVT)	
Ground Rejection	Automatic ground balance	
Search Mode	Motion detector	
Controls	Power (On/Off)	2 pos. switch
	Boost (Shallow/N/Deep)	3 pos. switch
	Threshold	1 turn control
	Volume	1 turn control
	Signal	1 turn control
	Tone	1 turn control
	Tune	push switch
	Level Adjust	1 turn control
	Iron Discriminate (All Metal/Disc)	2 pos. switch
	Soil (Sensitive/N/Salt)	3 pos. switch
Coil (Double D/M/Cancel)	3 pos. switch	
Balance (Fixed/Tracking)	2 pos. switch	
Audio Output	6.35mm (1/4") headphone socket	
	Headphones	Supplied
Coil (standard)	Extreme 1100 (Double D)	
	Extreme 1800 (Double D)	
Battery	6VDC 12A/hr sealed lead acid	14-15hrs

Patents Apply

Note: In the interest of product improvement, Minelab reserves the right to make changes without notice.

## ASSEMBLY AND LIST OF PARTS

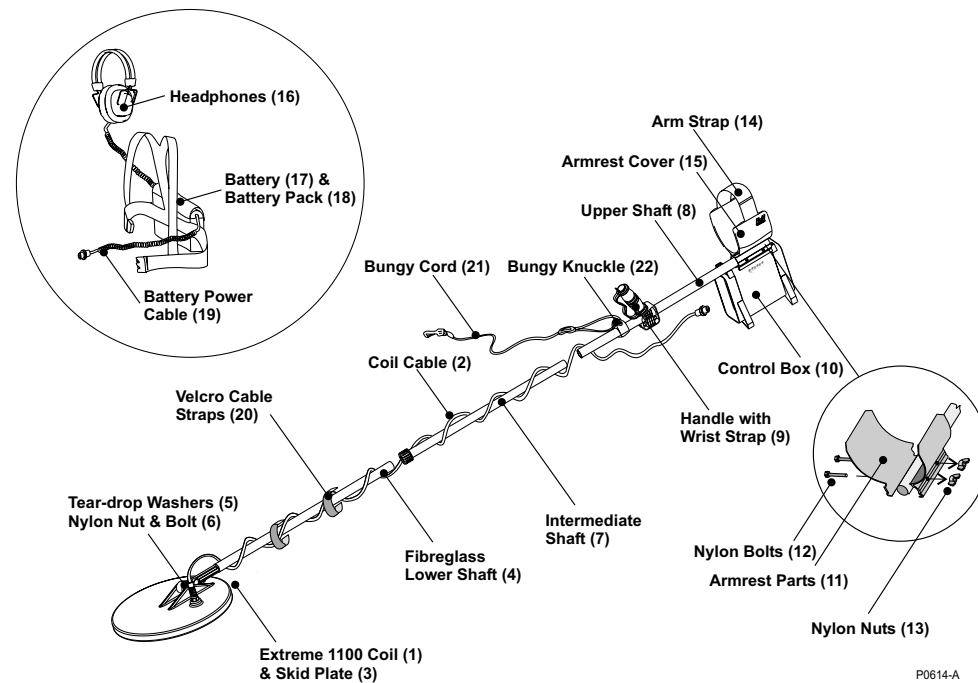

### A. Lower Shaft Assembly

1. 11" Double D Coil
2. Coil Cable
3. Skid Plate
4. Fibreglass Lower Shaft
5. Nylon Nut & Bolt
6. Teardrop Washers

### B. Intermediate Shaft Assembly

7. Intermediate Shaft

### C. Upper Shaft Assembly

8. Upper Shaft
9. Handle with Wrist Strap
10. Control Box
11. Armrest Parts (2)
12. Nylon Bolt (2)
13. Nylon Nut (2)
14. Arm Straps (2)
15. Armrest Cover

### D. Headphones

16. Headphones

### E. Battery and Battery Pack

17. Battery
18. Battery Pack
19. Battery Power Cable

### F. Extras

20. Velcro Cable Straps (3)
21. Bungy Cord
22. Bungy Knuckle

Figure 2.2 Pre-assembled sections and parts list



## COMPLETE ASSEMBLY INSTRUCTIONS

*You will need to assemble the 'GP 3000' from all the various components, here are detailed assembly instructions.*

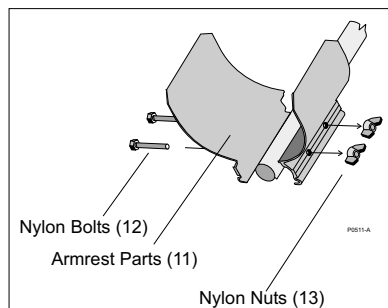

Figure 2.3 Armrest assembly

### Assembling and fitting the armrest

Figure 2.3, refer also Figure 2.2

- STEP 1 Place the two armrest halves (11) on either side of the upper shaft (8) and ensure that the bolt holes are aligned.
- STEP 2 Slide the two nylon bolts (12) through the bolt holes and screw the nylon wing nuts (13) onto the bolts by a couple of turns.
- STEP 3 Slide the 'T' section on top of the control box (10) into the armrest with the battery plug at the rear. Tighten the nylon wing nuts by hand.
- STEP 4 Attach the arm rest straps (14) using the press studs on both sides of the arm rest.
- STEP 5 Push the arm rest straps (14) through the slots in the neoprene arm rest cover (15) and then push the cover over the arm rest (11).

# 7

## User Info

This chapter provides a glossary of terminology, user guides, technical specifications, warranty and repair details and troubleshooting tips.

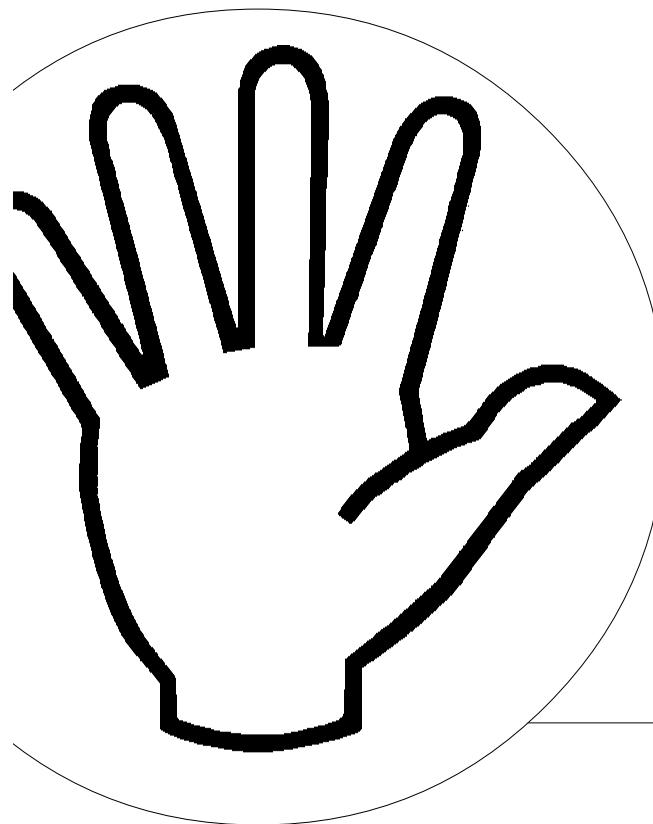

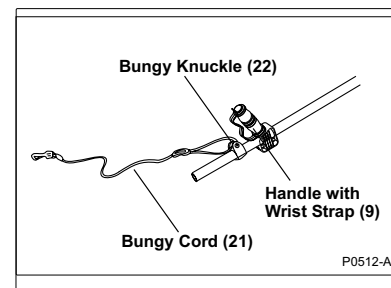

Figure 2.4 Handle and bungy cord

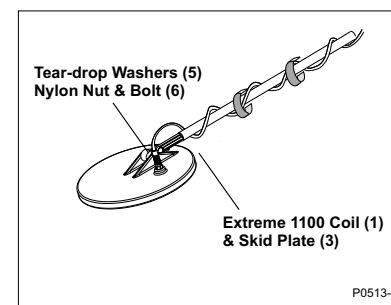

Figure 2.5 The coil pivot end of the lower fibreglass shaft

## Attaching the handle and bungy cord

Figure 2.4, refer also Figure 2.2

- STEP 1** Slide the handle (9) onto the other end of the upper shaft (8) and set it to a comfortable position. Tighten the two screws in the base of the handle with a small flat tipped screwdriver to hold the handle in position.
- STEP 2** Slide the bungy cord knuckle (22) of the bungy cord onto the upper shaft (8).

## Assembling the Intermediate and Upper shaft sections

Figure 2.5, refer also Figure 2.2

- STEP 1** Slide the intermediate shaft (7) into the end of the upper shaft (8) and snap into place.
- STEP 2** Check that the coil (1) has a skid plate (3) attached.
- STEP 3** Check that the coil pivot end of the lower fibreglass shaft (4) has two teardrop washers (5) installed.

**NOTE** The washers should always be full thickness and should be replaced regularly as they wear out and allow the coil to become loose.

- STEP 4** Push the lower fibreglass shaft (4) into the mounting brackets on the coil and ensure that the spring clip at the rear of the fibreglass shaft faces the rear of the coil.

## Attaching the coil

Figure 2.5

- STEP 1** Line up the holes in the coil with the pivot end of the fibreglass shaft (4).
- STEP 2** Push the nylon bolt through the holes and fit the nylon wing nut then tighten by hand.

**NOTE** Do not over tighten the nut as the coil housing may be crushed or damaged.



### Attaching the lower fibreglass shaft

Figure 2.2

- STEP 1** Slide the lower fibreglass shaft (4) into the intermediate shaft (7).
- STEP 2** Adjust shaft length and coil angle for a comfortable position. Minelab recommends that the shaft length be set to give a comfortable sweep length of approximately 2 meters. The lower fibreglass shaft can be set into position by locating the spring clip into the holes provided in the intermediate shaft and hand tightening the locking nut at the end of the intermediate shaft.

#### HINT

If the coil cable is able to move around, especially near the coil, it will be 'seen' by the detector and cause random noises which may be confusing.

### Securing and connecting the coil cable

**NOTE** Always ensure that the control box is turned off completely before connecting or disconnecting the coil.

- STEP 1** Wind the coil cable around the shaft and plug the coil connector into the coil socket on the control box. Check that the cable is wound firmly around the shaft without strain, leave enough slack at the bottom of the cable near the coil to allow for adjusting the angle of the coil without placing strain on the coil cable.
- STEP 2** Fasten the cable into position using the Velcro straps provided (20).

#### CAUTION

Use only the 6v DC battery supplied

### Fitting and connecting the battery pack

Figure 2.6

- STEP 1** Fit the battery (17) into the back pack pouch (18).
- STEP 2** Connect the headphones (16) and the power cable (19) to the appropriate sockets in the cap of the battery.
- STEP 3** Put on the back pack (18).

### Salty Environments

The 'GP 3000' will find objects at greater depth in salty environments. However, the interfering signals caused by highly concentrated salt may not be able to be completely 'balanced out' if using automatic ground balance alone.

**HINT** Change **Soil** switch to **Salt** setting for salty environments.

To use the salt setting, you will have to use the specially designed 'GP 3000' range of coils.



## HINT

When the object has been recovered, it may be worthwhile sweeping the hole again to ensure that there are no other targets.

If you find an object in a particular location, search the surrounding area very carefully. It is likely that there are more objects nearby.

If you hear a target signal, keep searching until you find the object; it is there and may be valuable

STEP 9 Keep halving the pile which has the target.

STEP 10 If it is still difficult to find the target, place the detector on the ground with the coil horizontal.

STEP 11 Take a handful of the diggings and pass over the coil.  
Your hands and wrists must be free of any metallic jewellery and watches.

STEP 12 If there is no signal, place the handful carefully in a new pile and repeat with another handful.

**NOTE** Always refill any holes before leaving, and scatter leaves, etc. to restore the area to its original condition. Any rubbish you recover should be taken away with you and disposed of properly.

### Recovering Deep Targets

The 'GP 3000' has depth capabilities that will surprise both new and experienced prospectors. If the target appears to be buried deeply, it should help to use the following technique:

STEP 1 Use the cross sweeping method to locate the target accurately.

STEP 2 Dig a hole large enough to insert the coil, approx. 100mm deep.

STEP 3 Keep testing the target location as you dig deeper.

STEP 4 Take care that the target is not in the wall of the hole. You may dig past it. Try pinpointing again to check your hole is in the correct position.

**REMEMBER** Removing rubbish and refilling holes will help metal detector users maintain a good reputation. This should lead to more areas being readily accessible for prospecting.

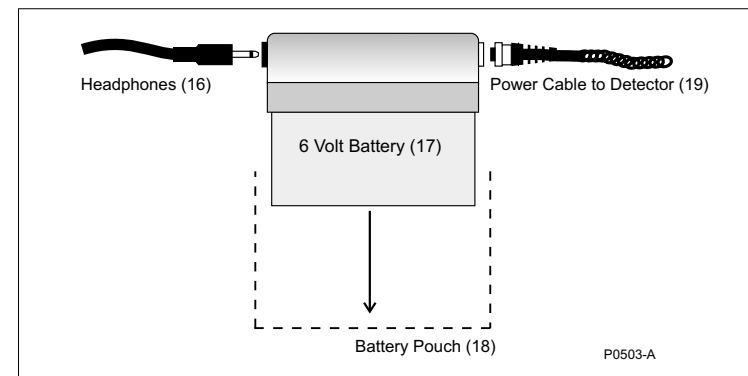

Figure 2.6 The 'GP 3000' battery assembly

STEP 4 Ensure that the power switch on the control box is switched off and plug the connector on the power cable (19) into the battery connector plug on the control box. This cable connects the battery and headphones to the detector.

### Adjust for your own comfort

STEP 1 Adjust the bungy cord (21) from the knuckle (22) on the shaft to correct length to take some of the weight when prospecting.

STEP 2 Adjust the hand strap on the handle (9) for your own comfort.



## RECOVERING THE TARGET



*When you are sure of the location of the target, it is necessary to dig a small hole to recover it. In order to preserve the environment, the hole should be as small as possible. Always replace the soil and grass which is removed.*

It is essential to carry at least one of the following digging tools with you when searching:

- small, strong digging spade
- pick
- shovel
- and crowbar (for very deep objects in hard ground).

**STEP 1** Before digging, clear the area of loose surface material and check that the target signal is still there. If it is not, the target should be amongst the surface material.

**STEP 2** If the target signal is still present, dig to a depth of approx.50mm.

**STEP 3** If the target cannot be seen, sweep the coil over the hole.

**STEP 4** If the target signal is not heard, then the target should be in the pile just dug.

**STEP 5** Check that there are no objects buried in the soil under the pile.

**STEP 6** Take care when you dig, as damaging a nugget may reduce its value. Start digging approx.100mm in front of the target to reduce the chance of damage.

**STEP 7** Pile the diggings carefully as it may be necessary to search them.

**STEP 8** If the target is located in the soil which was removed, sweep the coil over the pile and pinpoint its exact position.





3

# Battery

The 'GP 3000' is supplied with a 6v DC rechargeable battery pack plus both mains and vehicle chargers. This chapter provides details on battery installation, use and performance.



## Pinpointing

To find an object, and reduce the size of the hole required to remove it from the ground, it is necessary to pinpoint the exact location of the object.

If a target is heard, first confirm it by setting an accurate ground balance and then pinpointing. To ground balance, the coil should be passed around the area of the target, making sure that the target is not detected (keep the coil away from where the target is)

While the coil is moving around the area of the target, change **Balance to Fixed**. This will give a very accurate 'ground balance' on this area. One of the pinpointing techniques may then be used.

When a target is detected, sweep the general area with the coil, taking note of where the strongest signal is received.

By shortening the length of the sweep it should be possible to draw an imaginary line in the ground where the strongest signal is located.

Line up the target at 90° from the initial direction and repeat the process. The object is located where the two imaginary lines cross (see Figure 6.4).

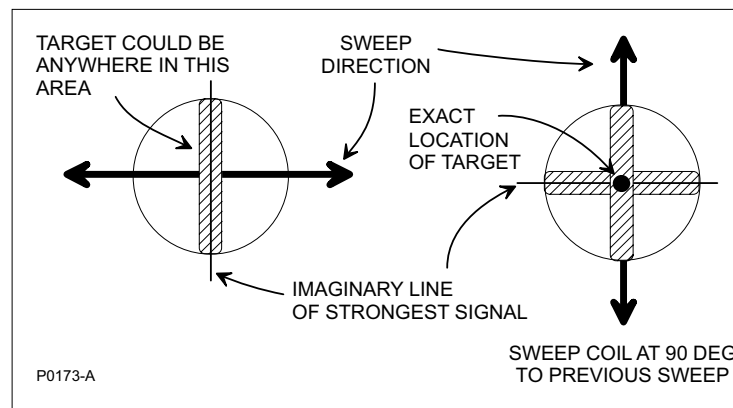

Figure 6.4 Pinpointing technique

**NOTE** Pinpointing will not locate a target in the *centre* of the coil if operating with the Coil switch set to M (Mono) or Cancel.



## BATTERY AND CHARGING

### The Battery

The 6v DC rechargeable battery should provide enough power to operate the detector for 14-15 hrs, when fully charged.

The battery may be recharged at any time during the discharge cycle.

It is very important to fully charge the battery before storage.

Do not leave a battery fully discharged for longer than one day.

**CAUTION** Never use a 12v DC battery because this would damage the detector. This damage is not covered by warranty.

### Low Battery Indication

If battery level drops below the desired power to give full function, a series of signal pulses are given at 0.5 second intervals.

#### Important

When charging, the battery must be kept in an upright position.

#### Caution

Do not leave the mains charger on for extended periods because reduced battery life may result.

### Charging the battery

STEP 1 Turn the detector **Off** before disconnecting the battery.

STEP 2 Disconnect the battery cable from the detector and connect to the appropriate charger.

### Battery Chargers

Two types of battery chargers (Mains and 12v Vehicle Charger) are supplied.

## IDENTIFYING TARGET SIGNALS

*Metallic targets will usually give a 'solid' sounding signal when the coil is swept across the object from any direction. Ground noises usually give a broad uneven signal when the coil is swept from different directions. A metallic target generally produces a short, sharp and mostly symmetrical signal.*

If you are not sure if the sound is ground noise or a target signal, you need to investigate.

Scrape a shallow hole about 70-100mm deep over the suspected target. Sweep the coil over the hole at the original ground level.

Do not dip the coil into the hole. If the signal has decreased in volume or is less defined, it is probably ground noise.

If the signal remains the same or becomes louder, it is likely a metallic target. If you are still not sure, make the hole deeper and repeat the process. You may also notice that mineral noises are often experienced from one direction only, on the return swing it is no longer there.

A 'halo effect', which may be built up around a buried metal object, makes the object appear to be larger to the detector than it actually is. This will be reduced once the target is disturbed from its position in the ground (e.g. a small object, detected at a substantial depth, may be more difficult to detect once recovered from the ground. If the object is reburied, the 'halo effect' will disappear)

**HINT** Do not try to eliminate what might appear to be a faint, isolated ground noise by balancing the detector because you may be 'balancing out' the target response from a deeply buried metallic target.

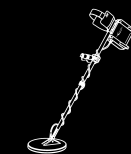

## PROSPECTING TECHNIQUES

*The 'GP 3000' has superior ground balancing and it is possible to find quite large objects near the surface in well-worked areas where other detectors have been unable to cope with the high degree of mineralisation and / or salt. Therefore the user should dig all target signals, even in previously detected areas.*

### For Maximum Gold Recovery

Keep the coil as close to the ground as possible.

Listen very carefully - this is more important than looking.

**SLOW DOWN!** Do not rush, take your time.

Very sudden or large changes in the mineralisation of an area may produce a signal from the detector.

In the Victorian goldfields, a response may be received from a concentration of orange/reddish dyke material or clay. In the loamy conditions of Western Australia, a pocket of dark orange/reddish colouration may produce a sudden signal change.

If detecting areas of extremely variable mineralisation, detecting with the contours rather than across the changes will often stabilise the effect.

In some ground (particularly heavily mineralised areas) the operator may need to sweep the coil 1 or 2 cm above the ground. This should give a more stable threshold and less ground noise.

**Charcoal** may sometimes produce signals, similar to a metallic object, when close to the surface. Charcoal is usually created by farmers burning off tree stumps or by bushfires.

When the charcoal under the surface is disturbed, the signal will vanish.

If in doubt, scrape away some soil above the suspect signal; if the signal gets stronger, it is likely to be a target. Dig it!

### Caution

**The Vehicle Battery Charger is designed for use with vehicles which have a negative earth electrical system.**

Most cars manufactured after 1970 should have negative earth electrical system.

Connecting the charger to a vehicle with a positive earth system will cause the fuse in the cigarette lighter plug to blow and the LED indicator will not light.

### Mains Battery Charger

The mains battery charger will charge the battery from local mains (AC) power outlets.

**STEP 1** Connect the mains charger to a mains outlet.

**STEP 2** Switch the mains outlet on.

Check the charger nameplate; it should be rated at 500mA or 1000mA. The 500mA charger will recharge a completely flat battery in approximately 20 hours. The 1000mA charger will recharge a completely flat battery in approximately 10 hours.

Partially discharged batteries require a shorter period to recharge. Allow approximately 1.5 to 2 hours charging for each hour the battery was in use if using a 500mA charger and about 0.5 to 0.75 hours for each hour usage on a 1000mA charger.

### Vehicle Battery Charger

The vehicle battery charger will charge the battery from the cigarette lighter socket of most motor vehicles.

**STEP 1** Connect the charger to the cigarette lighter socket and turn the ignition switch to Accessories.

This supplies 12v DC power to the cigarette lighter socket. This voltage is converted by the charger to charge the detector battery. A red LED indicator will flash while the battery is charging. When the battery is flat the LED may flash fast enough so as to appear constantly on. As the battery charges, the LED will flash at a slower rate.

**STEP 2** Leave the battery to charge for approx. 10 hours using this charger.

If the battery voltage of your vehicle drops below 11v, the charger will stop operating. Therefore the battery charger should not flatten the vehicle battery.

Check that your vehicle battery is in good condition before camping in remote areas.

Run your engine above idle speed for at least 30 minutes each day to keep your vehicle battery charged.

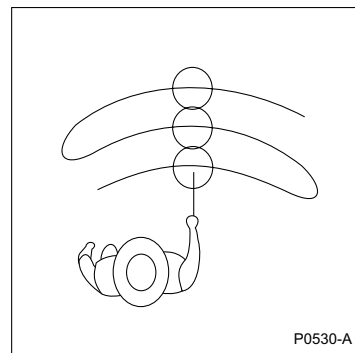

Figure 6.2 Search path

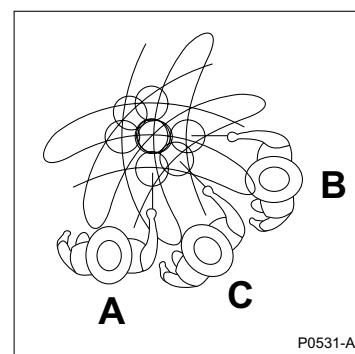

Figure 6.3 Search area from 3 directions

### Covering the search area

#### Figure 6.2 and Figure 6.3

- As the user moves forward slowly, the search pattern should resemble a snaking path.
- To ensure that the ground is thoroughly searched, approach the area from 3 different directions.

### Overlap each sweep

- Each sweep of the coil should overlap the area covered by the previous sweep to ensure a full coverage of the area being searched.
- Be aware of the search pattern of the coil being used and overlap sweeps to take this pattern into account.
- See also **Pinpointing Technique**, pages 43 and 44.

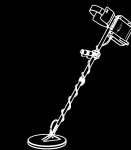

## DETECTING TECHNIQUES

### Check your footwear



**Note:** When detecting, do not wear steel cap boots or shoes with metal eyelets!

### Some user tips:

- The battery should be worn in the backpack supplied. This places the battery at the furthest practical distance from the coil.
- Ensure that you do not set the shaft length too short.
- If the coil is too close to your body it might detect your pick, the battery or any other metal which you are carrying. If false signals are occurring as you sweep the coil, check that they are not produced by any metal that you are carrying.
- Move the coil closer, and then further away from your body, in order to check if the signals are coming from items such as your pick or battery. If they are, you must increase the distance between the coil and these items.

### Motion detection

*The 'GP 3000' is a 'motion' detector. Therefore the detector must be moving over a target to detect it.*

### Parallel Sweeping Procedure

Figure 6.1

- The coil should be swept over the ground in a side-to-side sweeping motion.
- While sweeping the coil, it is important to keep it parallel to, and at the same height from, the ground at all times. Lightly skidding the coil across the ground can sometimes help in this, depending on mineralisation.
- Do not raise the coil at the ends of each sweep as this will reduce the detection depth and may cause false signals.

# 4

## Controls

It is important to familiarise yourself with the features of the 'GP 3000' control panel. A few minutes spent reading this chapter will be a worthwhile preliminary to detecting.





## DETECTOR SOUNDS

## easy reference

**Threshold and Tone**

This is the background sound produced by the detector. The level is set using the **Threshold** control. The **tone** of the **threshold** is set using the **Tone** control.

**Target Signal**

This is the abrupt change of the tone and volume of the threshold sound when a target is detected.

- The maximum level is set by the **Volume** control.
- The amount of tone variation is set by the **Signal** control.
- If the tone falls first and then rises, as the coil is passed over a target, this generally indicates a small target.
- If the tone rises first and then falls, as the coil is passed over a target, this generally indicates a large target.

**Ground Noise**

These are irregular noises that are difficult, or impossible, to pinpoint when moving the coil over the ground. Ground noise is caused by the changing chemistry or 'mineralisation' of the ground. When the Balance switch is set to **Tracking** these effects are greatly reduced.

**Tune Indication**

An initial beep sounds then, while the detector is testing the range of frequencies for the most stable, the threshold may become more quiet or chattery. Once selection is complete three sharp 'beeps' are given.

**Low Battery Indication**

If the battery level drops below the desired power to give full function, a series of signal pulses are given at 0.5 second intervals.

## 6

# Detecting Techniques

Hints and techniques for better detecting and happy prospecting that will help you to utilise the power of your 'GP 3000' with DVT.



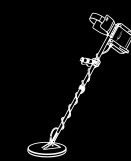

DISCRIMINATION CONTROL USING LEVEL ADJUST

# easy reference

MIN (FULLY ANTI-CLOCKWISE)	MAX (FULLY CLOCKWISE)
Most iron objects are discriminated, but a few small iron objects will be accepted as non-ferrous.	Almost all iron objects are discriminated, but a few small non-ferrous items will also be ignored.
Detect <i>more</i> rubbish, but less likely to cancel a gold nugget.	Detect <i>less</i> rubbish, but may mistake a nugget for ferrous rubbish
Suggested for areas with <i>large</i> amounts of ferrous rubbish.	Suggested for areas with <i>small</i> amounts of ferrous rubbish
Only <i>very strong</i> target responses will trigger discrimination action.	Both <i>strong and medium</i> target responses will trigger discrimination action
<b>Tracking</b> is <i>more</i> likely to balance out weak target responses.	<b>Tracking</b> is <i>less</i> likely to balance out weak target responses.
A <i>medium to strong</i> target response should pause the tracking mode but weak responses may be mistaken for ground mineralisation.	A <i>weak</i> target response should pause the tracking mode.

## CONTROL FUNCTIONS

There are two control panels: the rear panel and the front panel.

### Rear Panel

Figure 4.1



Figure 4.1 Rear Panel

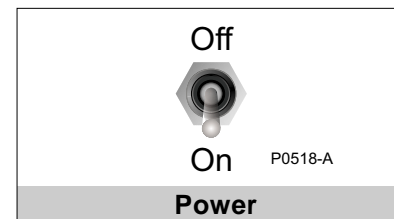

Figure 4.2 Power (On/Off) switch

### Power (On/Off)

Figure 4.2

This switch turns the power from the battery to the detector **On** and **Off**.

**NOTE** Always switch the detector **Off** before connecting or disconnecting the coil or battery pack and when not in use.

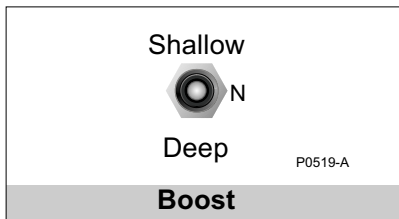

Figure 4.3 Boost switch

### Boost (Shallow/N/Deep)

Figure 4.3

Enhances the signals produced by different types of targets.

- **Shallow** enables target signals, from small objects close to the surface of the ground to be amplified. This allows for easier detection. This setting is best suited for 'quiet' ground.
- **N (Normal)** may be used for normal detecting conditions. This setting responds to all signals without boosting.
- **Deep** may be used when searching for large targets at greater depth in 'noisy' ground. Random soil signals are smoothed, making small changes in the audio signal from large deep targets easier to hear. This may mask some signals from very small targets near the surface.

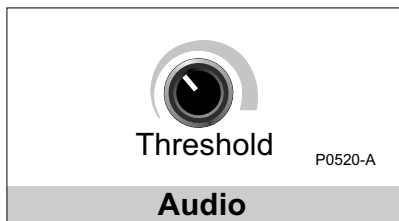

Figure 4.4 Threshold control

### Threshold

Figure 4.4

Adjusts the background audio signal or 'threshold' level.

The **Threshold** control should be set just above the point where the threshold is just audible and stable.

This level should not be at a level where prolonged use may be irritating. Ideally it should be a smooth, gentle hum.

**NOTE** Small targets or large deep targets may not produce a distinct target signal, but may cause only a small variation in the threshold level. If the threshold level is set too high or too low, these very small variations may be missed.

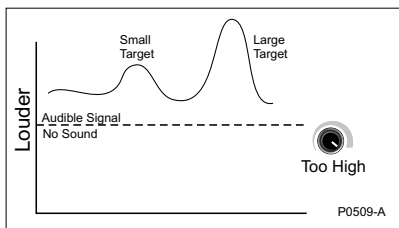

Figure 4.5 Threshold control too low

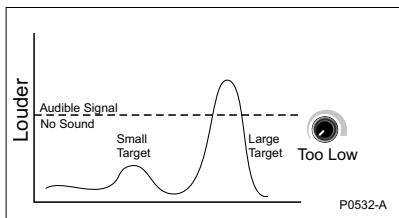

Figure 4.6 Threshold control too high

In Figures 4.5 - 4.7, the dotted line represents the level at which the audio output becomes audible; signals cannot be heard if they are below the dotted line.

If the threshold level is set too high then small variations in audio signal might not be discernible above the threshold level (Figure 4.5). An example of this would be to hear a whisper within a crowded noisy room.

### Level Adjust Control

**Level Adjust** gives the user the ability to select the sensitivity and likelihood of a target being discriminated as ferrous when used in the **Disc** mode.

This may also affect how the detector responds to ground mineralisation compared to metal targets when used in **Disc** Mode.

There is usually some overlap between signals from useful targets and some types of iron rubbish. The user may set **Level Adjust** to select the amount of discrimination between two extremes:

- **(Fully anti-clockwise)**. All targets detected, but some iron will give a normal signal (as per Figure 5.4).
- **(Fully clockwise)** Little iron detected, but some small non-ferrous targets potentially mistaken as ferrous.

Turning the control anti-clockwise increases the strength of a signal required for iron discrimination to be activated.

The **Level Adjust** also affects the **Tracking** mode.

When set fully clockwise, it is unlikely the detector will *'balance out'* genuine targets, but some ground noise may still give false signals.

When set fully anti-clockwise, the detector will *'balance out'* ground noise effectively, but some faint, weak target signals may be missed after repeated sweeps of the coil.

**HINT** It is usually best to dig out all targets and only use the discrimination function in areas where a large amount of rubbish makes the digging of everything impractical.

**NOTE** Discrimination functions will only work with strong, positive target responses. Weak responses will give normal *'all metal'* type signals.



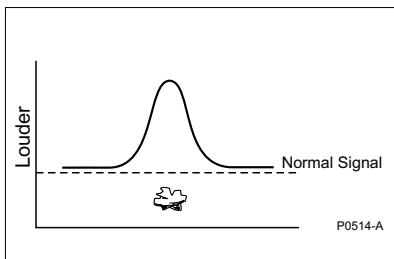
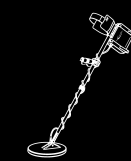

Figure 5.4 A normal signal on a non-ferrous target.

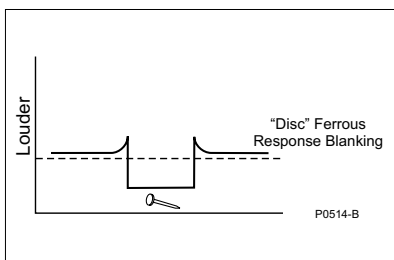

Figure 5.5 Discrimination target signal on a ferrous target.

## Iron Discriminate

Figures 5.4, 5.5

Iron discrimination with the 'GP 3000' is the silencing or 'blinking' of the threshold which occurs when the detector determines a target is comprised of ferrous metal.

There is no discrimination when **Iron Discrimination** is set to **All Metal**. Targets will cause the tone and volume of the threshold to vary. These variations convey no consistent information about the type of metal detected.

Iron discrimination operates when **Iron Discriminate** is set to **Disc**. Objects must produce sufficiently strong target responses for the detector to successfully discriminate. Fortunately, most iron rubbish is located near the surface and should produce the required strong signal response.

**NOTE** When **Disc** is used, small or deeper targets, whether ferrous or non-ferrous, will produce a normal target signal.

If a target response is too weak for the detector to discriminate, it will internally change to the all metal mode. As soon as the target response becomes strong enough, the detector will resume discrimination.

Pinpointing is best performed using **All Metal**.

**HINT** When a target has been located using **Disc**, the coil should be rapidly passed back and forth over the target centre several times. Remember to set **Balance** to **Fixed** for this.

The coil should always be passed smoothly over the surface of the ground, while maintaining the coil height above the ground. This is especially important when attempting to discriminate a target.

**NOTE** Discrimination will give the best results when used in combination with the specially designed 'GP 3000' coils.

When detecting a piece of iron, a normal target signal should be heard until the detector determines that the object is ferrous.

At this point, the signal will 'blank'.

The strength of the target response required for discrimination to occur may be altered by using **Level Adjust**.

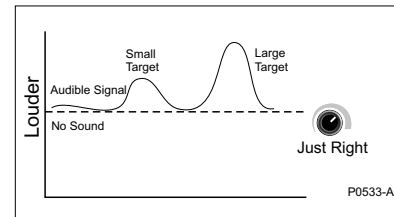

Figure 4.7 Threshold control just right

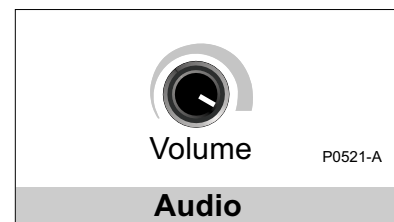

Figure 4.8 Volume control

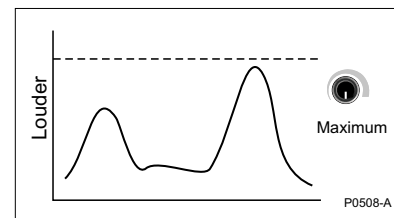

Figure 4.9 Maximum volume

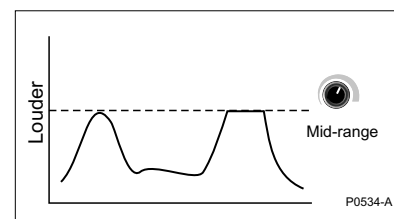

Figure 4.10 Mid-range volume

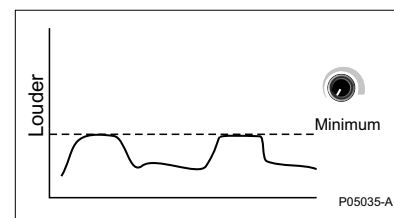

Figure 4.11 Minimum volume

If the threshold level is set too low there is no audible background signal and small target signals will not go above the threshold of audibility (Figure 4.6).

**HINT** A soft audible headphone signal which is comfortable to listen to for extended periods is recommended (Figure 4.7).

## Volume

Figure 4.8

Sets a maximum limit on the loudness of the target signal obtained from a large target. Refer to Figures 4.9 - 4.11. The dotted line in these figures represents the level of volume set by the volume control.

- If the **Volume** is set to maximum (fully clockwise), the target signal is unaltered and proportional to the target size and depth (see Figure 4.9).
- If the **Volume** control is turned down to half way, the target signal is unaltered for a small target, but is limited for a bigger target (see Figure 4.10).
- If the **Volume** were to be turned down close to minimum, it potentially will limit all signals to such a degree that most targets will be lost (see figure 4.11).

**NOTE** Threshold should be reset after adjusting the **Volume** level.

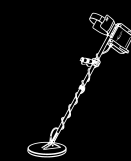

Figure 4.12 Signal control

### Signal Pitch

Figure 4.12

Adjusts the pitch response of the target signal.

In Figures 4.13 and 4.14 the curving line represents the high/low pitch response to a target. The dotted line represents the threshold tone.

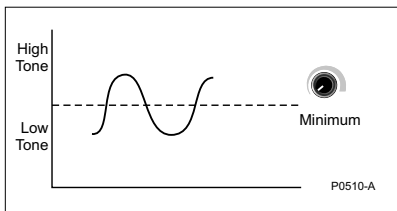

Figure 4.13 Reduced pitch variance

- At minimum position the high/low pitch variance to a target is reduced.
- At maximum position the high/low pitch variance to a target is increased.

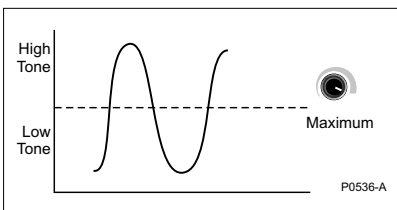

Figure 4.14 Increased pitch variance

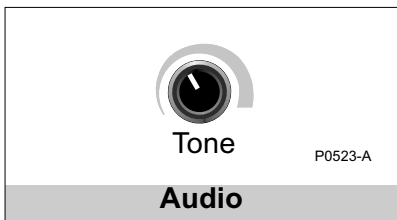

Figure 4.15 Tone control

### Tone

Figure 4.15

Adjusts the tone of the threshold. The user may set this to the preferred tone, e.g. the tone at which the operator's hearing is most sensitive.

At minimum position, threshold is set at a low tone. Turning clockwise increases the tone to higher pitch.

## IRON DISCRIMINATION

*Discrimination is the ability of a detector to distinguish between different types of metal objects and to assist the user in identifying a target.*

*Some goldfields are littered with 'rubbish', e.g. metal objects which are of little value and are an annoyance to detector users.*

*The 'GP 3000' is capable of rejecting many iron objects while still detecting non-ferrous metals. The ability of the detector to discriminate ferrous targets means that, while detecting in littered goldfields, much of the iron rubbish may be ignored, with a high probability that valuable targets will not be missed.*

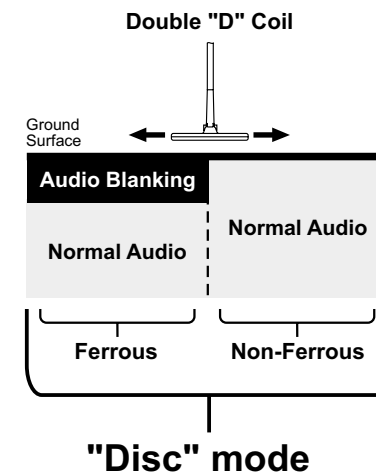

<b>Target Signal:</b>	<b>Ferrous:</b> Target signal blanks as coil passes over target
	<b>Non-Ferrous:</b> Signal is more steady as coil passes over target

NOTE: The above zoning is only a stylistic example of how the Discrimination mode works. The above areas are not determined by depth but by the strength of signal.

P0507-A

P0507-A

Figure 5.3 Discrimination levels

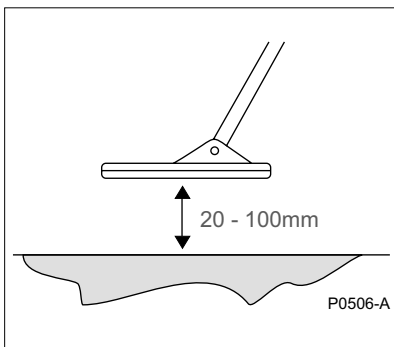

Figure 5.2 Setting the ground balance

### Ground Balancing Procedure

Figure 5.2

- Move the coil up and down between 20mm and 100mm above the ground and, while moving the coil, change **Balance** from **Fixed** to **Tracking**.
- The fast ground balance takes only 5 sec. after switching to **Tracking**. Therefore, it is important to be moving the coil as the switch is changed.
- Keep moving the coil until all ground noise has stopped. A persistent signal may indicate a target in the ground.
- If this occurs, then move the coil to a new location and repeat the procedure.
- When there is no longer a change in the threshold, while the coil is being raised and lowered, the detector is '*ground balanced*'.
- When the detector has been ground balanced, the user may select either **Fixed** or **Tracking** for detecting.

If the ground is mineralised or variable, use **Tracking**.

If the ground is very '*mild*', use **Fixed** and switch back to **Tracking** temporarily if the threshold becomes noisy. Do not test a target by switching to **Tracking** when the coil is above it.

**HINT** It may be useful to repeat the ground balance procedure if ground conditions change rapidly.

### Front Panel

Figure 4.16



Figure 4.16 Rear Panel

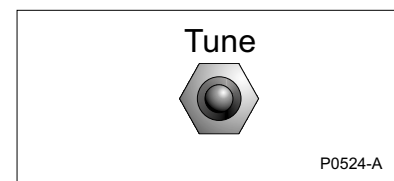

Figure 4.17 Tune control

### Tune

Figure 4.17

Reduces the effects of electromagnetic interference from sources such as power lines, radio transmitters and other metal detectors.

Automatic tuning is started by pressing and releasing the Tune switch.

The tuning process takes approx. 60 sec. and completion is indicated by three sharp 'beeps'.



Figure 4.18 All Metal/Disc switch

### Iron Discriminate (All Metal/Disc)

Figure 4.18

Selects between discrimination or to turn off the discrimination altogether (**All Metal**).

In **All Metals**, the detector will give varying volume and pitch signals but this information does not indicate the type of metal in the object.

In **Disc**, a strong response from a ferrous (iron) object will cause the threshold to be 'blanked' or silenced.

**NOTE** If the target response is too weak for accurate discrimination, the detector will give a normal target signal.

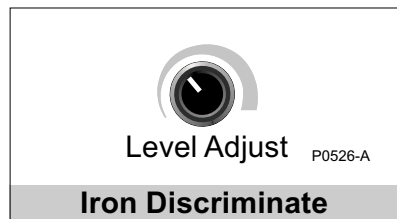

Figure 4.19 Level Adjust control

### Level Adjust

Figure 4.19

**Level adjust** gives the user the ability to select the sensitivity and likelihood of a target being ferrous or non-ferrous.

It also affects how the detector recognises mineral effects in the ground, as opposed to metal targets, when '*ground balancing*'.

**NOTE** It is important that you read pages 37 and 38 in Chapter 5 for more information.

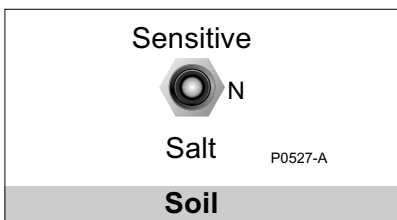

Figure 4.20 Soil (Normal/Sensitive/Salt) switch

### Soil (Normal/Sensitive/Salt)

Figure 4.20

Optimises the detector for different soil conditions and targets by changing the signal processing.

- **N (Normal)** may be used in all areas, including areas with highly mineralised soil. This position has very good sensitivity to a wide range of nugget sizes and is the most versatile of the three positions.

## GROUND BALANCING

### HINTS

Use '**Tracking**' in areas with very high ground noise for best results.

If '**Balance**' is changed to '**Fixed**', the detector will no longer adjust to changes in ground mineralisation, but will stay fixed at the level previously calculated while in '**Tracking**' mode.

Change from '**Tracking**' to '**Fixed**' when pinpointing a potential target.

The ground contains not only sand, but also many different chemicals, minerals and salts. These extra materials are referred to as ground mineralisation.

This ground mineralisation may often produce a sound from the detector, known as 'ground noise'.

The '*GP 3000*' has the ability to cancel out the effects of ground mineralisation. This minimises ground noise and retains maximum sensitivity to metal targets. Cancelling the effects of ground mineralisation is referred to as 'ground balancing'. This ensures that target signals from objects, such as gold, are not confused with interfering ground noise.

The '*GP 3000*' has automatic ground balancing. This continually adjusts to minimise the effects of ground mineralisation when **Balance** is set to **Tracking**.

The '*GP 3000*' may be operated with fixed ground balance or automatic ground balance.

- When **Balance** is set to **Fixed**, the ground balance remains at the current level.
- When **Balance** is changed from **Fixed** to **Tracking**, the detector begins to automatically ground balance through a two stage process.

The first stage is a very rapid adjustment to the ground mineralisation. This only lasts for 5 sec. so coil movement should be at the same time as **Balance** is changed from **Fixed** to **Tracking**.

The second stage continues to adjust to the ground mineralisation, but at a greatly reduced speed.

This adjustment continues all the time that **Balance** is set to **Tracking**.

While in **Tracking** mode, the detector usually stops ground balancing when a target signal is detected. However, a weak target response may not be recognised as a target if the coil is repeatedly passed over an object and it may be '*balanced out*'. For this reason **Balance** should be changed to **Fixed** when pinpointing a target.

### NOTE

The **Level Adjust** control also effects the **Tracking** mode by altering the detectors perception of what is ground noise and what is a weak target (see pages 37 and 38).



Sometimes it may not be possible to remove the effects of interference completely by using the **Tune** control alone.

Once the detector has been tuned for a particular location, it should not require readjustment unless conditions change or new interference is introduced, e.g. other detectors being used in the same area. If the interference persists after tuning, consider using the **Coil** switch set to **Cancel** position.

### Boost (Shallow/N/Deep)

Boost selects the type of processing and filtering applied to the detector signals.

- **N (Normal)** may be used for general detecting conditions. This does not boost any signals.
- **Shallow** boosts signals from small targets close to the surface. This makes faint target signals easier to hear. This setting may also boost any ground noise, therefore Shallow is well suited for 'quiet' ground conditions.
- **Deep** may be used when searching for large targets at depth. This smooths the threshold and target signals from small targets, making small changes in threshold easier to hear.

Selection of the more suitable position should be after considering both target size/depth and ground conditions.

**NOTE** When Boost is changed, Threshold may also need to be adjusted.

External amplifiers may be used in addition to the **Boost** switch, provided that they have loudness limiters built in. This prevents loud signals becoming unpleasant or dangerous to the user's hearing.

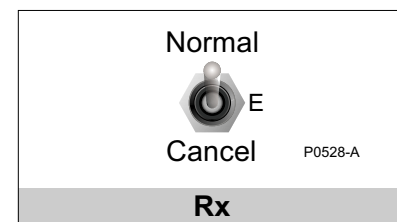

Figure 4.21 Rx (Receive) switch

- **Sensitive** may be used when searching for small nuggets, especially in areas with highly mineralised soil. The extra stability allows the coil to be used closer to the ground in areas of excessive ground noise. **Sensitive** may not work well if the ground is salty.

This setting may also reduce the depth at which large nuggets are likely to be found.

- **Salt** may be used in areas containing high salt content, be they neutral or heavily mineralised. In highly mineralised areas without salt, this setting may be less sensitive than **Normal** or **Sensitive** to small nuggets.

### Coil Double D/M/Cancel

Figure 4.21

Changes the sensitivity and search pattern of the coil to allow the 'GP 3000' range of coils to become multi-versatile coils with different characteristics to suit different environments. This is achieved by altering the pattern of transmit (TX) and receive (RX) fields of the coil and how the control box interprets the response.

- **Double D** can be used in most areas of medium to very high mineralisation, being the most able to cope with ground noise. It is also excellent for pinpointing targets as the response is strongest from the centre of the coil.
- **M (Mono)** may be used in most locations of low to medium mineralisation and for locating small nuggets with **Soil** switch set to **Sensitive**. Pinpointing is not centred in the middle of the coil, but to one side and may give a complex signal when the target is very close to the coil.
- **Cancel** may be used in areas with very high electrical interference where the **Tune** function has difficulty selecting a quiet operational frequency (e.g.: near power lines, electric fences or under poor atmospheric conditions).



Pinpoint in **Cancel** will again be to one side of centre and signals may be complex if target is close to the coil. This setting will limit sensitivity to deep targets.

**NOTE** Coils not specifically designed for the 'GP 3000' may behave erratically or be ineffective in either **M (Mono)** or **Cancel** modes.

Minlab Monoloop coils can be used on the GP 3000 with excellent results. When using a Monoloop coil on the GP 3000 we would recommend you operate the coil switch in **M (mono)** position.

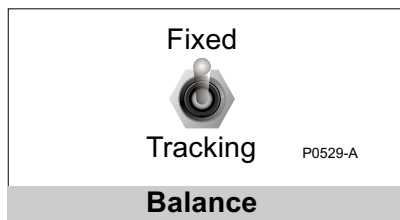

Figure 4.22 Balance (Fixed/Tracking) switch

### Balance (Fixed/Tracking)

Figure 4.21

The 'GP3000' may be operated with fixed ground balance or automatic ground balance.

- When **Balance** is set to **Fixed**, the ground balance remains at the current level.
- When **Balance** is changed from **Fixed** to **Tracking**, the detector begins to automatically ground balance through a two stage process that is described on page 33.

To obtain the best performance from your detector, it is important to know how different ground conditions affect the detecting process. See "Ground Balancing" on page 33 for more detailed information.

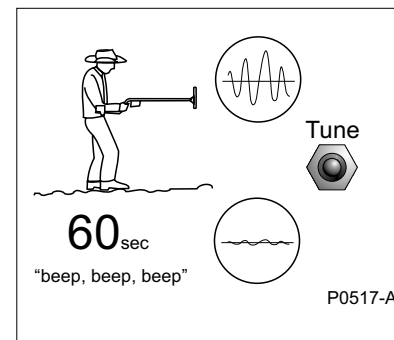

Figure 5.1 The tuning process

**IMPORTANT**

When tuning detector in close proximity to other detectors, each operator needs to take turns tuning. Do not try to tune two detectors at one time.

**M (Mono)** changes the way the coil transmits and receives its signals. Operating in mono, the coil has some of the characteristics of a Monoloop coil. Use of Mono will often increase the sensitivity of the detector but may also be a little more unstable in heavily mineralised ground. Pinpointing will be off to the left of centre.

**Cancel** changes the electromagnetic field of the coil so that it is particularly stable in areas of electrical interference. This position is ideal in areas where the operator wants to detect close to suburbia or under power lines etc.

### Set the Tune control

Figure 5.1

Tuning should be done initially with the **Coil** switch in **Double D** or in **M (Mono)**. If the interference is still severe after completing the tuning operation, change the **Coil** switch to **Cancel** and then re-tune detector again.

- Hold the detector at waist height and the coil vertical.
- Keeping the coil vertical, slowly move it through a half-circle around your body.
- Listen for an increase in interference as you move the coil.
- When the interference is loudest, stop moving the detector, hold it motionless in that position and momentarily press the **Tune** switch.

The detector will then scan through the available range of transmission frequencies and automatically select the frequency that results in the greatest reduction of noise from electromagnetic interference.

- The end of tuning process (which takes approx. 60 sec.) is announced by three beeps.

While the detector is selecting the preferred frequency, the coil must be kept motionless and clear of metal objects.



### Set the Tone control

Adjust the Tone control until the threshold is at a comfortable tone for your hearing. Interpretation of the target signals involves understanding the difference between the rising and falling tone and volume of the threshold in response to different targets.

**HINT** Setting Tone to a high pitch may be more fatiguing, but is more suitable for identifying the faintest target signals.

### Set the Signal control

The human hearing is sensitive to changes in tone, so the operator is more likely to hear a target signal when both the volume and the tone change rather than volume alone.

The **Signal** control gives the operator the ability to choose between a target signal that has a large variance of tone, or one which has less variation.

High variance can give the operator more signal definition to interpret, however in highly mineralised ground this high variance of signal may cause confusion and a lower setting is preferred.

### Soil switch

Use this switch to optimise the detector's ability to detect in different ground conditions (see page 24 for full description).

### Coil switch

Selection of different positions of this switch, changes the electromagnetic field of the coil thus giving better performance in certain environments (see page 25 for more information).

**Double D** has the coil operate in a conventional Double D search pattern with all the same advantages and disadvantages.

#### IMPORTANT

You will need to re-ground balance every time you select a new position for either the 'Soil' or 'Coil' switches.

# 5

# Operation

However experienced you are at using a metal detector, it is important that you read this chapter to understand how to use the 'GP 3000' to its full capacity.





## QUICK START INSTRUCTIONS

## easy reference

- STEP 1 Set **Coil** switch to Double D.
- STEP 2 Set **Soil** switch to N (Normal).
- STEP 3 Set **Balance** switch to **Fixed**.
- STEP 4 Set **Iron Discriminate** switch to **All Metals**.
- STEP 5 Set **Boost** to **N (Normal)** for general detecting.
- STEP 6 Set **Volume** to maximum, and Signal to 2 o'clock.
- STEP 7 Turn **Power** switch on.
- STEP 8 Adjust the **Threshold** control so that a faint sound is heard through the headphones.
- STEP 9 Adjust the **Threshold Tone** to suit your hearing.
- STEP 10 To tune the detector, hold at waist height with the shaft horizontal. Keep the coil vertical.
- STEP 11 Slowly move coil around your body through a half-circle until the noise from interference is loudest.
- STEP 12 Hold this position, keep the coil motionless and push the **Tune** switch once to start the tuning function.
- STEP 13 Tuning takes approximately 60 seconds. A series of three beeps will indicate that the optimum frequency has been selected.
- STEP 14 For **Discrimination**, change the **Iron Discriminate** switch to Disc and set **Level Adjust** to the middle of its range.
- STEP 15 Set the Ground Balance by moving the coil up and down. While coil is in motion, change **Balance** switch from **Fixed** to **Tracking**.
- STEP 16 Once ground balance has been achieved switch back to **Fixed**.
- STEP 17 The detector is now ready for operation.

## DETAILED OPERATING INSTRUCTIONS

## HINT

Take time to read this manual thoroughly to obtain the best performance from your new 'GP 3000' detector.

## Turn the 'GP 3000' On

Hold the coil away from the ground and metal objects and switch Power to On.

**NOTE** When the 'GP 3000' is turned Off, important information (e.g. tuning frequency and ground balance) is saved in internal memory.

If detection recommences in the same location, the user should not have to re-tune or re-ground balance the detector.

## Set the Volume Control

Volume should be set so that target signals are clear and easy to hear but loud signals are not uncomfortable to your hearing.

Set the Volume by passing the coil across a large target and adjusting volume to a comfortable level. Now test a very small target at this level.

## Set the Threshold control

Adjust the Threshold control until the threshold is just audible through the headphones.

**NOTE** Small surface objects, as well as large deep objects, will produce very small changes in the threshold. It is important to set the Threshold control correctly to ensure that these targets are heard. Experiment with known targets to assist in setting all controls to suit your hearing.